

EntraGuard® Platinum Telephone Entry Controller

Installation Guide

This installation guide provides, basic installation information, drawings, and controller setup instructions to use when installing the EntraGuard Platinum Telephone Entry controller. The EntraGuard Platinum controller may be used alone or may be connected to an access control network using PXL-500 family controllers. For instructions on how to install a postal lock, see the EntraGuard Platinum Postal Lock Installation Application Note (p/n 01964-001).

NOTE: It is the responsibility of the installation organization to have only technically qualified personnel performing the hardware installation.

1.0 Drawings

1.1 EntraGuard Platinum Enclosure

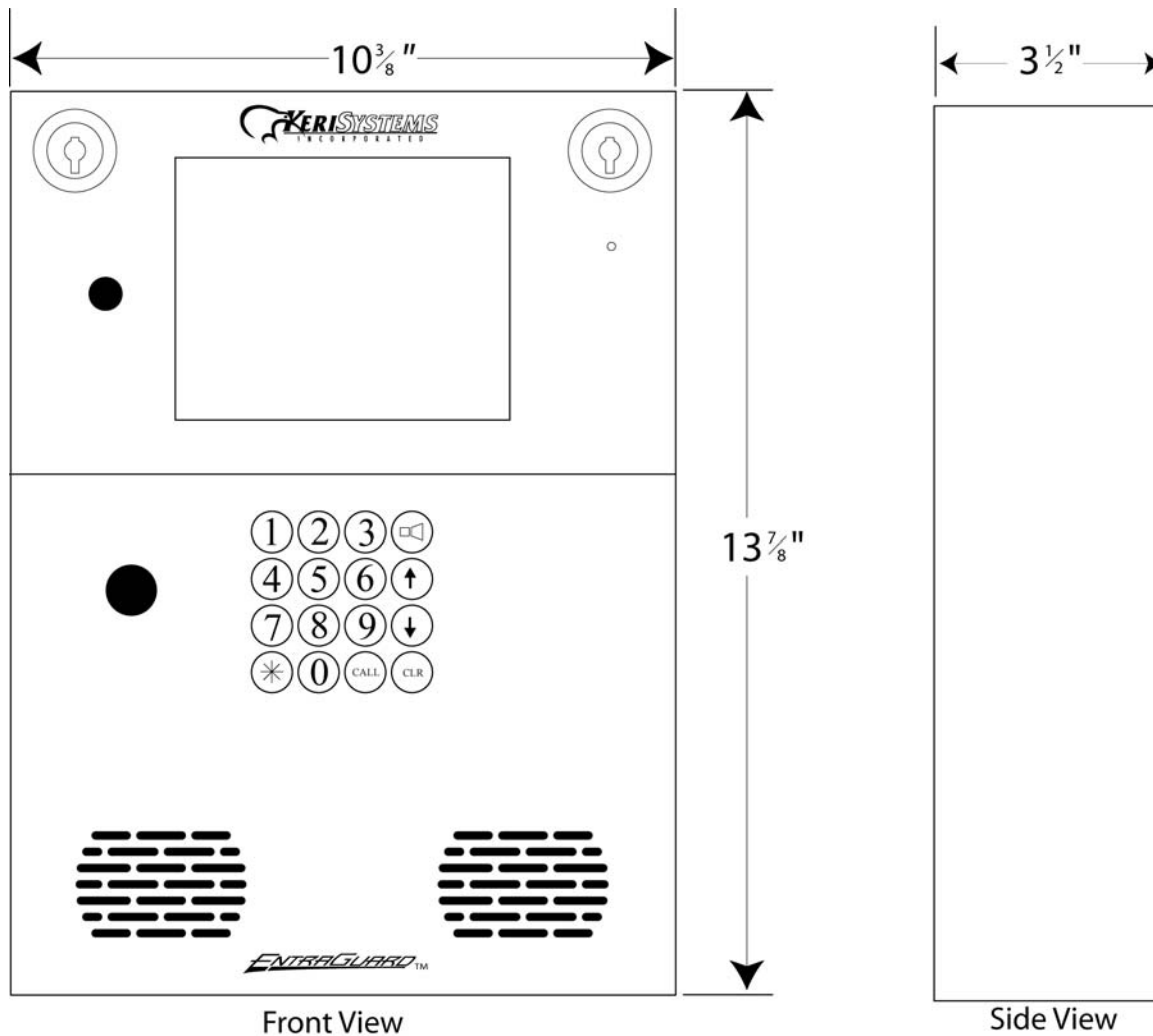

Figure 1: The EntraGuard Platinum Telephone Entry Controller

Wiring diagrams are provided for the new style Platinum controller PCB (p/n 05735-001, see Figure 3 on page 3) and old style Platinum controller PCB (p/n 05728-001, see Figure 4 on page 4).

NOTE: Power down the unit before making or removing any connections. Failure to do so will damage the controller.

NOTE: Please refer to the Compatibility_Guide_Series_3_and_4.pdf document (p/n 01876-001) for Doors software/Entraguard firmware compatibility.

EntraGuard[®] Platinum Telephone Entry Controller Installation Guide

1.2 Enclosure Mounting Diagram

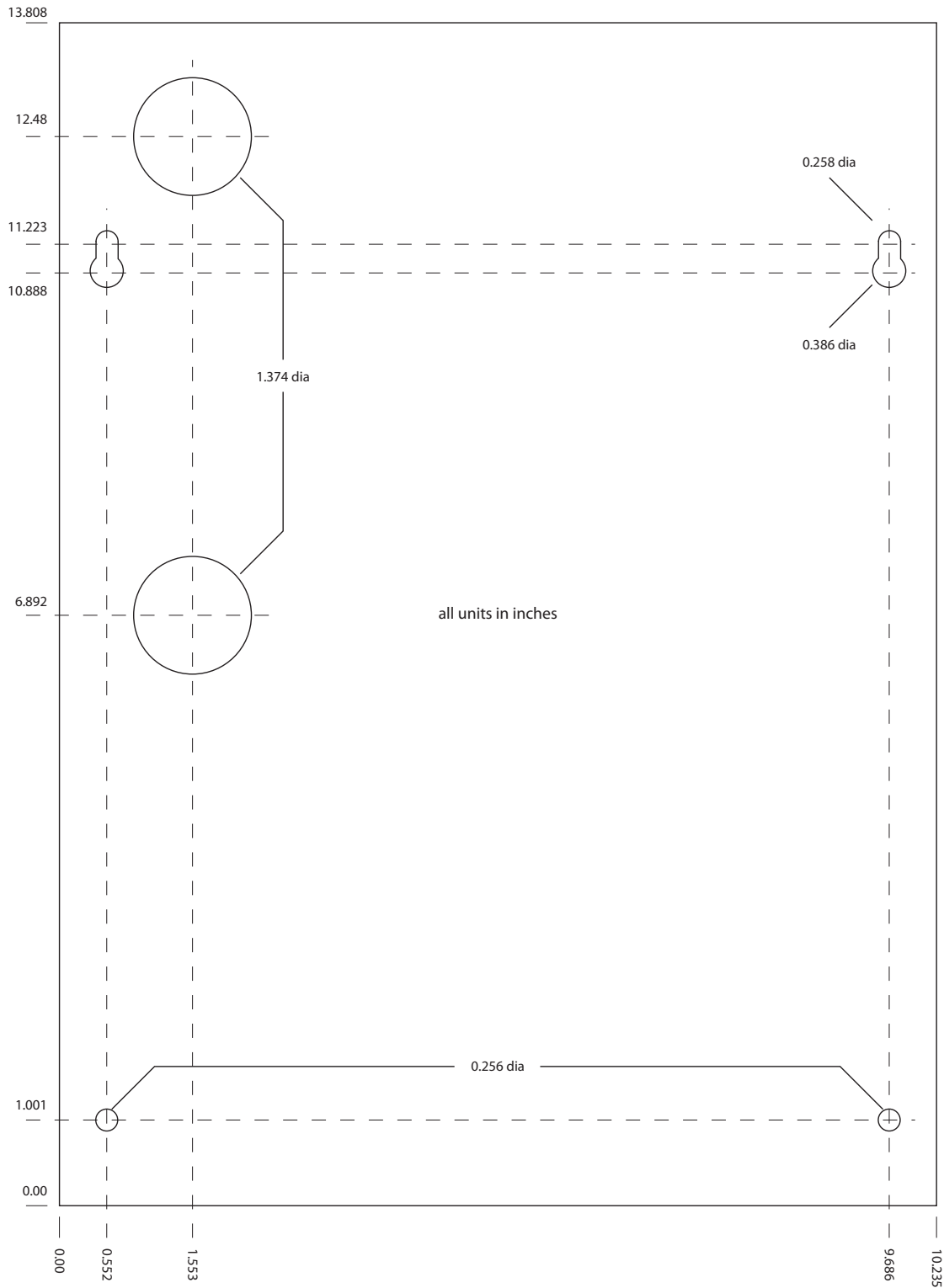

Figure 2: Entraguard Platinum Mounting Diagram

EntraGuard® Platinum Telephone Entry Controller

Installation Guide

1.3 New Style Platinum Controller

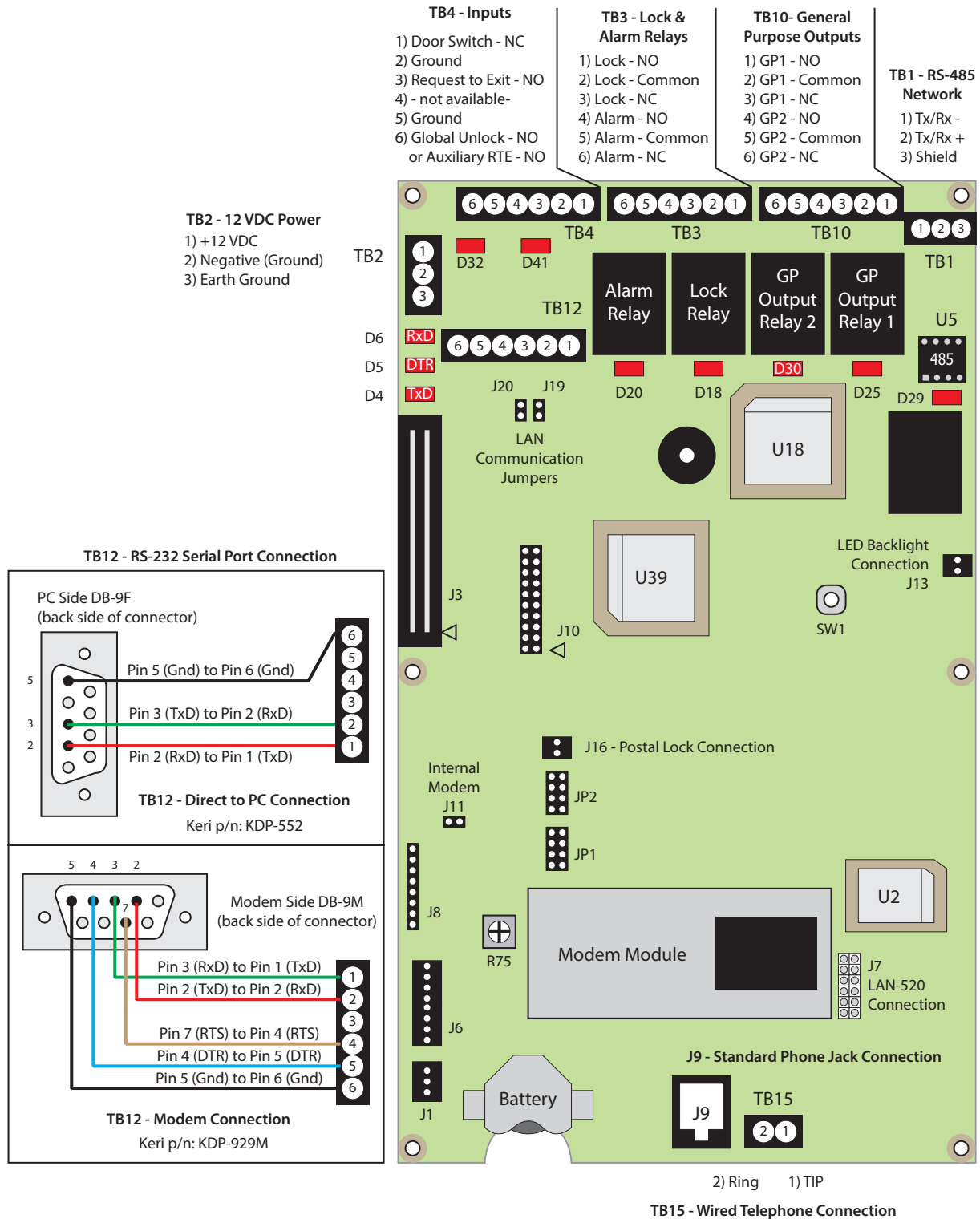

Figure 3: New Style Entraguard Platinum Controller – p/n 05735-001

EntraGuard[®] Platinum Telephone Entry Controller

Installation Guide

1.4 Old-Style Platinum Controller

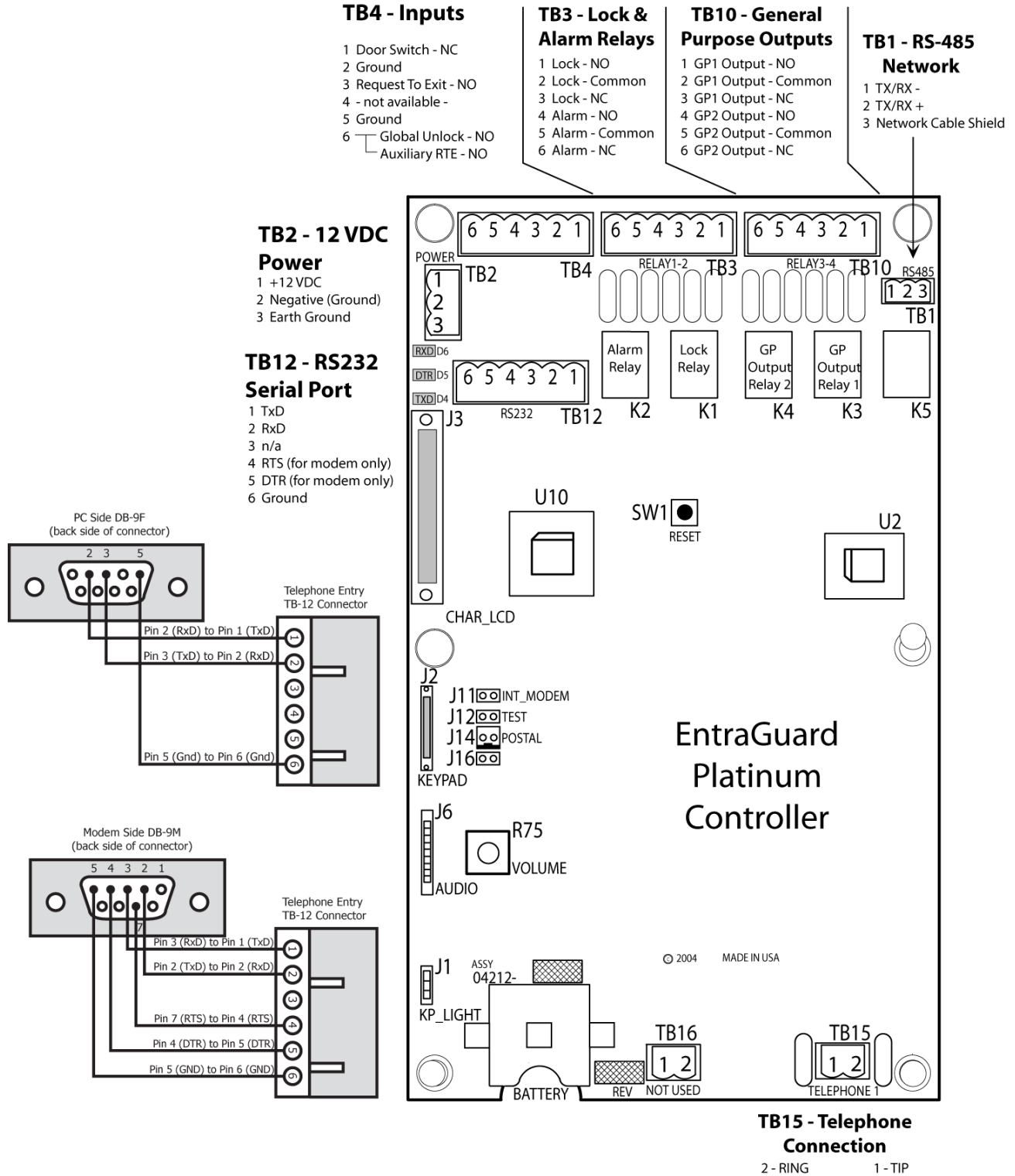

Figure 4: Old Style Entraguard Platinum Controller – p/n 05728-001

EntraGuard[®] Platinum Telephone Entry Controller Installation Guide

1.5 Board Placement for a PXL-500 Controller

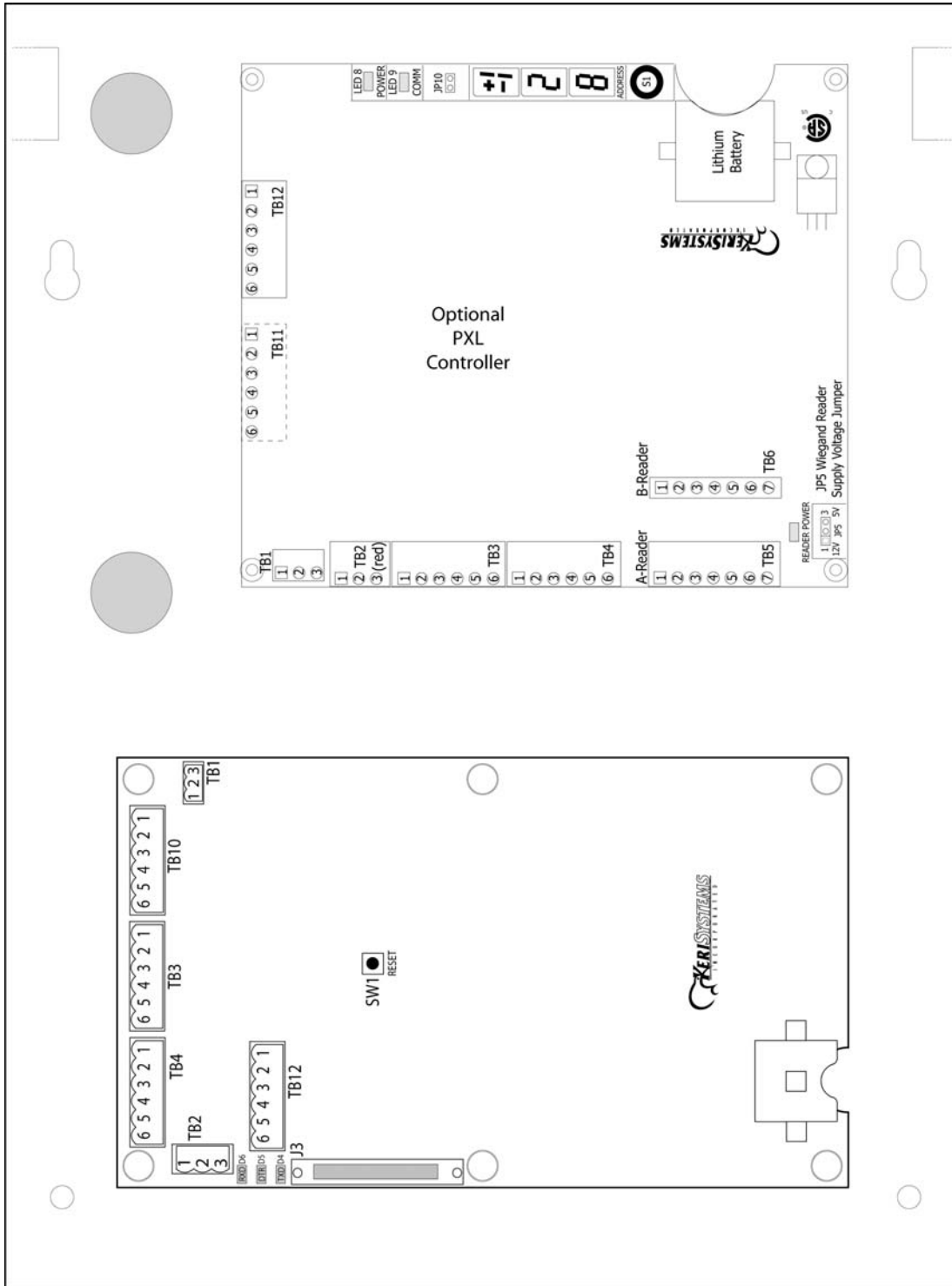

Figure 5: Platinum Board Placement with an Optional PXL-500 Controller

NOTE: For information on the optional PXL-500/PXL-510 board, see the [PXL-500 Installation Guide \(P/N 01530-001\)](#).

EntraGuard[®] Platinum Telephone Entry Controller

Installation Guide

2.0 Jumpers and LEDs

2.1 Jumpers

- J14 – connects to the Postal Lock on the Old Style Platinum Controller
- J16 – connects to the Postal Lock on the New Style Platinum Controller
- J11 – requires a jumper to enable communication through the internal PC modem
- J19 & J20 – requires jumpers to enable serial communication
- J11, J19, and J20 must all be removed for LAN operation which is only available on New-Style Controller PCBs

2.2 LEDs

NOTE: The Old Style unit will NOT have all LED indicators listed below.

- D32 – unit power ON
- D41 – reversed power/over current indicator
 - Red indicates reversed power
 - Green indicates over current condition
- D20, D18, D30, D25 – Relay active
- D29 – RS-485 shield connected on master controller
- D4, D5, D6 – RS-232 serial communication activity

3.0 Controller to Host PC Communication

There are two means of communication between the master controller and the host PC: serial RS-232 or LAN.

3.1 Serial RS-232

An RS-232 serial port connection is made by either:

- a direct serial connection (50 feet maximum)
- through an internal PC modem or external modem
- USB to serial converter – uses the Direct to PC serial connection

NOTE: If your PC has an internal modem, that modem may be prevented by the PC from properly operating with an Entraguard controller. For modem connections, Keri recommends using an external modem for reliable operation.

Refer to the insets in Figure 3 and Figure 4 for RS-232 serial port wiring information.

LED D6 will be green when there is proper RS-232 serial communication.

3.2 LAN

A LAN connection is made using a LAN-520 device connected to J7 on the New Style Entraguard controller. A LAN unit is only required for the master controller.

For LAN operation, **J11, J19, and J20 must be removed** (refer to Figure 3).

Please refer to the LAN-520X LAN Port Installation Guide (p/n 01504-001) for detailed information on configuring the LAN unit.

NOTE: LAN connectivity is not supported on the Old Style Controller board.

EntraGuard® Platinum Telephone Entry Controller

Installation Guide

4.0 Setup Controller

If you're turning system power on for the first time, certain tasks must be performed prior to entering access control information from *Doors*. On the EntraGuard Platinum main board (see Figure 3 on page 3 or Figure 4 on page 4), hold the Reset Button (SW1) down and turn the controller's power on. After the controller beeps once, indicating the controller's firmware is ready for programming, release the SW1 button. The LCD on the front panel will display the Reset Menu (see Figure 6). From this menu you may perform these tasks: set the controller's address, clear the controller's memory, set the microphone volume, run diagnostics, and set the LCD font.

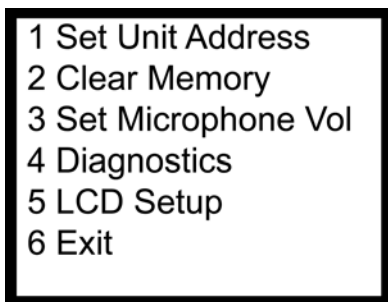

Figure 6: Reset Menu

NOTE: If no keys have been selected within 60 seconds, the unit will time out and go directly to the default message. In order to reach the Reset Menu, the unit must be powered up again.

4.1 Set Unit Address

The controller's address may only be set through the Reset Menu. To set the desired operating address for the controller, press 1 on the keypad. The Set New Unit Address screen appears on the LCD (see Figure 7).

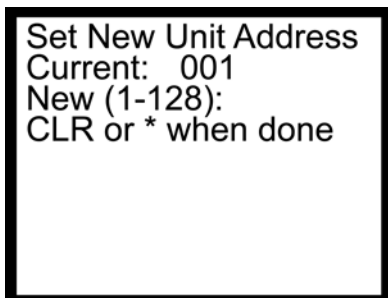

Figure 7: Set Unit Address

The address range is from 1 to 128. The Master Controller must be set to address 1. Other slave EntraGuard/PXL controllers may be assigned any number from 2 to 128.

If the address shown as Current is correct, you may either enter the same address and press *, or just press * to return to the reset menu. If you do not enter a new address, or enter the same address that is already assigned to this unit, you will need to clear the memory separately (see "Clear the Controller's RAM" on page 8).

NOTE: Changing the address of an EntraGuard Platinum controller completely erases all information within the controller. It is vitally important that you collect all data from the controller before changing the address. Once the address is changed (and the RAM is automatically cleared) the information in the controller is lost and cannot be recovered.

EntraGuard® Platinum Telephone Entry Controller

Installation Guide

If the address shown as Current needs to be changed, enter the new address by pressing the numbers on the keypad. The number selected will show in the New line. If you enter the wrong number, simply press CLEAR to erase what has been entered. When you are satisfied with the address entered, press *. If you have changed the number from what is shown as Current, **the controller will automatically clear the memory as it changes the address** (see Figure 8).

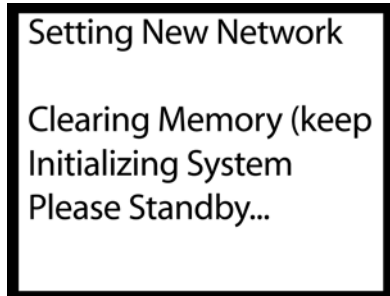

Figure 8: Setting New Address

Once the memory has been cleared, the unit is ready to be configured. The LCD will display a warning that the unit has not been initialized. This display will rotate with the EntraGuard Default display until a Total Update from *Doors* has been performed on the unit. Once an update has been performed, only the default will be displayed.

4.2 Clear the Controller's RAM

When turning system power on for the first time, the controller's memory needs to be cleared of any spurious information that may be in the RAM. If you changed the controller address, the memory is automatically cleared. However, if you did not change the address, you will need to clear the controller's RAM separately. From the Reset Menu (see Figure 6 on page 7), press 2 to Clear Memory. The Clear Memory screen will appear on the LCD (see Figure 9).

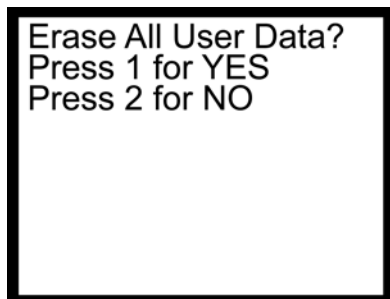

Figure 9: Clear Memory

From the Clear Memory Screen you may either:

1. Press 1 to clear the controller's RAM. The LCD will change to show the memory is being cleared (see Figure 10 on page 9). Once the controller's RAM has been cleared, the unit is ready for use. The LCD will rotate between the Initialization Warning and EntraGuard Default screens until a Total Update from *Doors* has been performed on the unit.

OR

2. Press 2 to return to the Reset Menu without clearing the controller's RAM.

NOTE: Clearing the system RAM completely erases all information within the EntraGuard Platinum controller, except for the controller address. If there is any information in system RAM from an access control installation and the system RAM is cleared, the information in the controller is lost and cannot be recovered, and a Total Update must be performed.

EntraGuard® Platinum Telephone Entry Controller

Installation Guide

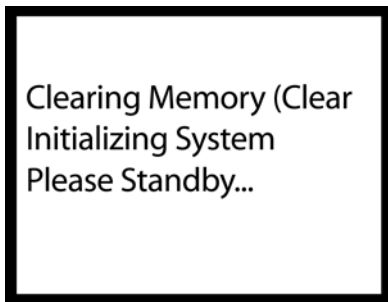

Figure 10: Clearing Memory

4.3 Diagnostics and Troubleshooting

For information regarding the diagnostics screens and troubleshooting the EntraGuard Platinum Controller, see the [EntraGuard Troubleshooting and Diagnostics Guide](#) (P/N 01912-001).

4.4 LCD Setup

The EntraGuard LCD (located on the front of the EntraGuard Platinum controller) is capable of using two different font sizes. The default is set for the large size. However, if the small size font would be preferred as the default, it may be changed through the reset menu. From the Reset Menu (see Figure 6 on page 7), press 5 for LCD Setup. The LCD Setup menu will appear on the LCD (see Figure 11).

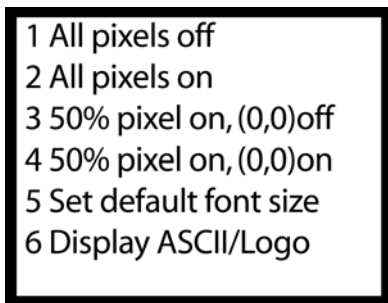

Figure 11: Setup LCD Menu

1. Select 5 on the keypad to change the default font size. The Set Font Default Menu appears (see Figure 12).



Figure 12: Set Font Default Menu

2. Press 1 to make the default font small.
3. Press 2 to make the default font large.

NOTE: Users may temporarily change the font size when using the EntraGuard Platinum controller, but any changes made will always return to the default as selected here.

EntraGuard[®] Platinum Telephone Entry Controller

Installation Guide

4. Once the font size is selected a Font set to small/large window appears (see Figure 13) corresponding to your selection.

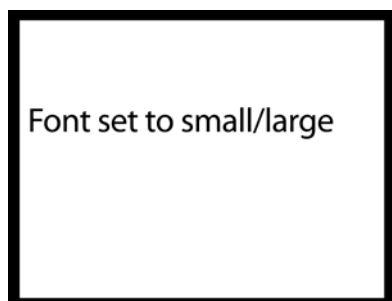

Figure 13: Font Set

5.0 Contact Keri Systems

Keri USA	Keri UK, Ireland, Europe
2305 Bering Drive San Jose, CA 95131	Unit 17 Park Farm Industrial Estate Ermine Street Buntingford Herts SG9 9AZ UK
Telephone: (800) 260-5265 (408) 435-8400	Telephone: + 44 (0) 1763 273 243
Fax: (408) 577-1792	Fax:+ 44 (0) 1763 274 106
Web: www.kerisys.com	Web: www.kerisystems.co.uk
E-mail: sales@kerisys.com techsupport@kerisys.com	E-mail: sales@kerisystems.co.uk tech-support@kerisystems.co.uk

- end of document -