

MR50 READER INTERFACE

Installation and Specifications:

This device complies with part 15 of the FCC Rules. Operation is subject to the following two conditions: (1) This device may not cause harmful interference, and (2) this device must accept any interference received, including interference that may cause undesired operation.

1. General:

The MR50 reader interface provides a solution to the OEM system integrator for interfacing to a TTL (D1/D0, Clock/Data), F/2F or RS-485 device, and door hardware. It also provides a tri-stated LED control and buzzer control. Two Form-C contact relay outputs may be used for strike control or alarm signaling. Two inputs are provided that can be used for monitoring the door contact and request to exit push button. Input circuits can be configured as unsupervised or supervised. Communication to the controller is accomplished via a 2-wire RS-485 interface. The MR50 requires 12 to 24 Vdc for power.

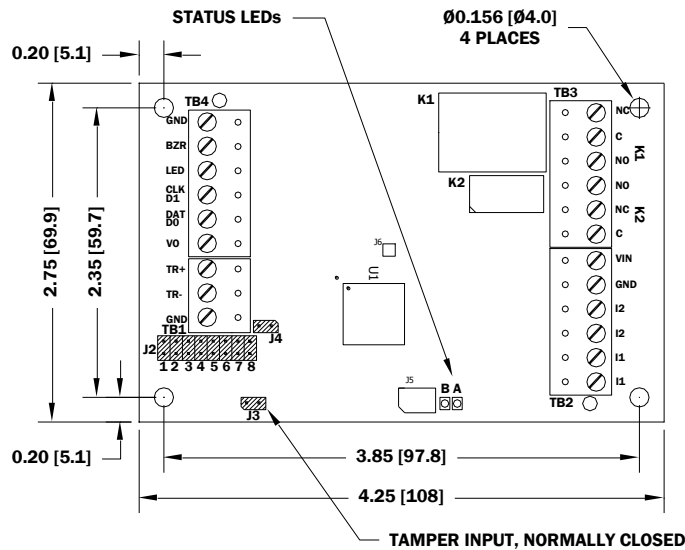

2. MR50 Hardware:

All interconnections to the interface are via quick-disconnect terminal blocks. The MR50 requires filtered 12 to 24 Vdc \pm 10% for power. Two inputs are typically used for door contact and exit push button monitoring. End of line resistors are required input supervision, shown below.

Note: The input power is passed through to the reader terminal strip and is available for powering a reader. Care must be taken to insure that the input voltage is within the voltage range of the reader.

 The reader power output terminal, TB4-6 (VO), is not current limited

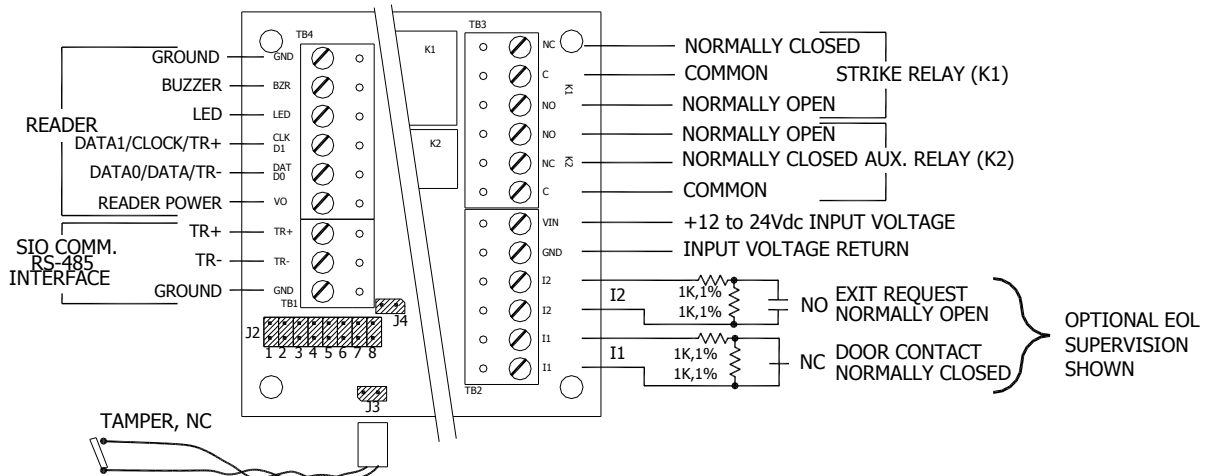

Information Subject to Change Without Notice

3. Reader Wiring:

The reader port supports a reader with TTL (D1/D0, Clock/Data), F/2F, or 2-wire RS-485 signaling. Readers that require different voltage requirements must be powered separately. Refer to the reader manufacture specifications for cabling requirements. In the 2-wire LED mode the buzzer output is used to drive the second LED. Reader port configuration is set via the host software.

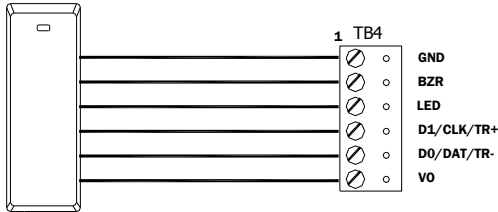

Typical D1/D0 or Clock/Data Reader

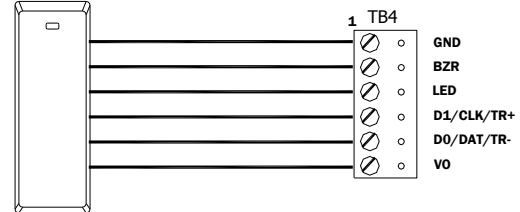

Typical RS-485 Device

* Inputs on supervised F/2F readers may be unsupervised or supervised (supervised shown).

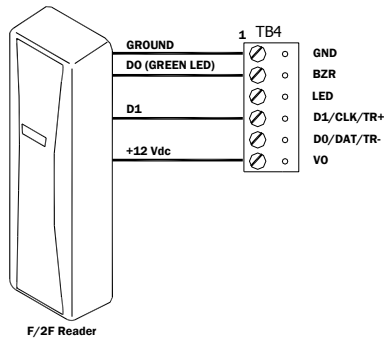

Typical Unsupervised F/2F Reader

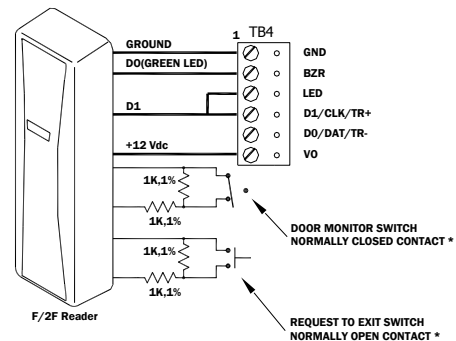

Typical Supervised F/2F Reader

⚠ Jumer D1 to LED on supervised F/2F readers

4. Door Strike Relay Wiring:

Two Form-C contact relays are provided for controlling door strike or other devices. The contact ratings are 5 A. for relay K1 and 1 A. for relay K2. Load switching can cause abnormal contact wear and premature contact failure. Switching of inductive loads (strike) also causes EMI (electromagnetic interference) which may interfere with normal operation of other equipment. To minimize premature contact failure and to increase system reliability, contact protection circuit must be used. The following two circuits are recommended. Locate the protection circuit as close to the load as possible (within 12 inches [30 cm]), as the effectiveness of the circuit will decrease if it is located far away.

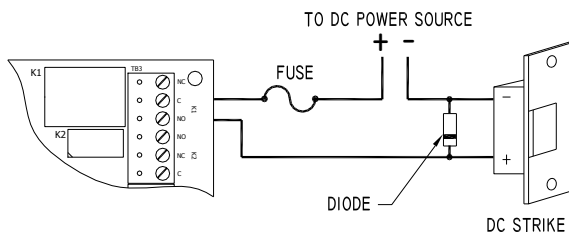

Typical DC Door Strike Wiring

Diode Selection:

Diode current rating: 1x strike current
 Diode breakdown voltage: 4x strike voltage
 For 12 Vdc or 24 Vdc strike, diode 1N4002 (100V/1A) typical

5. Communication Wiring:

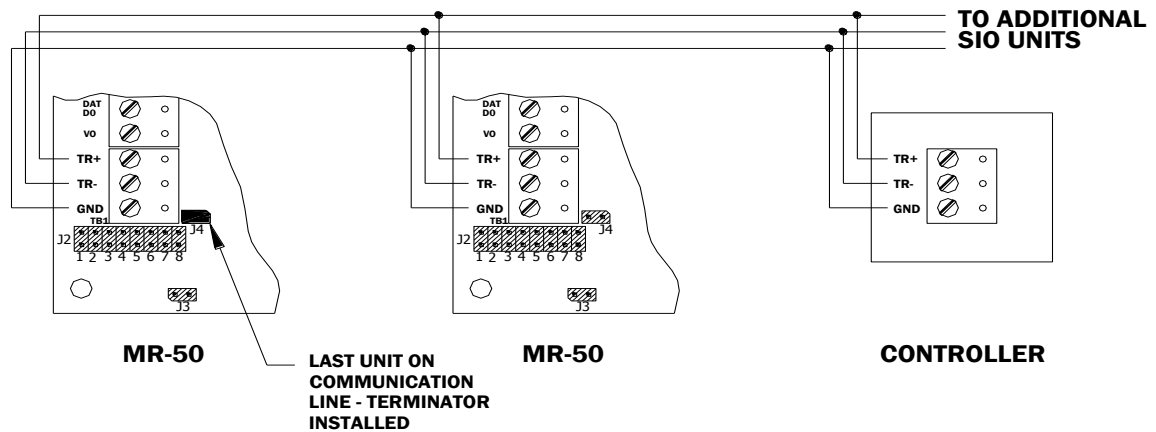

The MR50 communicates to a Mercury Security intelligent controller (EP2500 for example) via a half-duplex multi-drop 2-wire RS-485 interface. The total cable length is limited to 4,000 feet (1,219 meters). Shielded cable of 24 AWG with characteristic impedance of 120 ohm is specified for the 2-wire RS-485 interface. The last device on each end of the communication line should have the terminator installed (install jumper J4).

6. Address, Baud Rate and Encryption Configuration Jumpers:

Each Interface (MR50, MR52, etc.) must be configured to have a unique address and correct baud rate. The address and baud rate are selected by installing the specified jumpers.

Note 1: Firmware revisions prior to 1.39.1, the 115200 baud rate setting is 2400 baud

Note 2: Firmware revisions prior to 1.39.1, jumper 8 is not defined, remove jumper

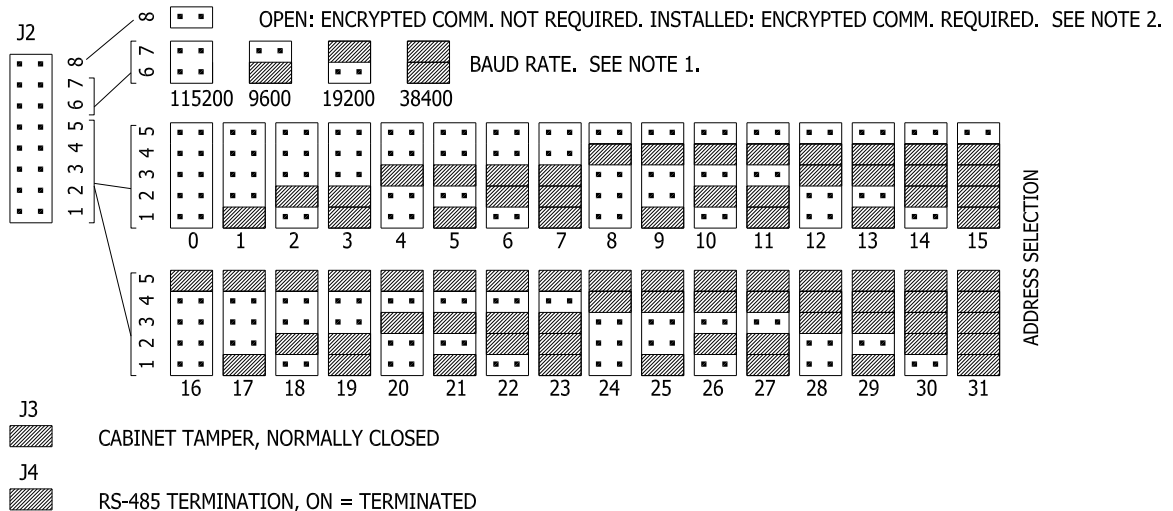

7. Status LEDs:

Power-up: All LED's OFF

Initialization: Once power is applied, initialization of the module begins

The **A LED** is turned **ON** at the beginning of initialization

Run time: After a successful initialization, the LEDs have the following meanings:

A LED: Heartbeat and On-Line Status:

Off-line: 1 second rate, 20% **ON**

On-line:

Non-encrypted communication: 1 second rate, 80% **ON**

Encrypted communication:

.1 S **ON**, .1 S **OFF**, .1 S **ON**, .1 S **OFF**, .1 S **ON**, .1 S **OFF**, .1 sec **ON**, .3 S **OFF**

A LED Error Indication:

Waiting for application firmware to be downloaded: .1 S **ON**, .1 S **OFF**

B LED: SIO Communication Port Status:

Indicates communication activity on the SIO communication port

8. Specifications:

The Interface is for use in low voltage, class 2 circuits only.

Primary Power: 12 to 24 Vdc \pm 10%, 150 mA maximum (plus reader current)

Outputs: Two Form-C contact relays: K1: 5 A @ 30 Vdc, K2: 1 A @ 30 Vdc

Inputs: Two unsupervised/supervised, standard EOL, 1k/1k ohm, 1%, ¼ watt
One unsupervised, dedicated for cabinet tamper

Reader Interface:

Reader power: 12 to 24 Vdc \pm 10% (input voltage passed through)

Reader LED output: TTL compatible, high > 3 V, low < 0.5 V, 5 mA source/sink maximum

Buzzer output: Open collector, 12 Vdc open circuit maximum, 40 mA sink maximum

Data Inputs: TTL compatible, F/2F or 2-wire RS-485

Communication: 2-wire RS-485: 9600, 19200, 38400 or 115200 bps

Cable Requirements:

Power: 1 twisted pair, 18 AWG

RS-485 I/O devices: 1 twisted pair with drain wire and shield, 24 AWG, 120 ohm impedance, 4,000 ft. (1,219 m) maximum

Alarm Inputs: 1 twisted pair per input, 30 ohms maximum

Outputs: As required for the load

Reader data (TTL): 6-conductor, 18 AWG, 500 ft. (150 m) maximum

Reader data (F/2F): 4-conductor, 18 AWG, 500 ft. (150 m) maximum

Reader data (RS-485): 1 twisted pair with drain wire and shield, 24 AWG, 120 ohm impedance, 2,000 ft. (610 m) maximum

Mechanical:

Dimension: 4.25 in. (108 mm) W x 2.75 in. (70 mm) L x 1 in. (25.4mm) H

Weight: 4 oz. (120 g) nominal

Environment:

Temperature: -55 to +85 °C, storage,
-40 to +75 °C, operating

Humidity: 5 to 95 % RHNC

Warranty

Mercury Security warrants the product is free from defects in material and workmanship under normal use and service with proper maintenance for one year from the date of factory shipment. Mercury Security assumes no responsibility for products damaged by improper handling or installation. This warranty is limited to the repair or replacement of the defective unit.

There are no expressed warranties other than set forth herein. Mercury Security does not make, nor intends, nor does it authorize any agent or representative to make any other warranties, or implied warranties, and expressly excludes and disclaims all implied warranties of merchantability or fitness for a particular purpose.

Returns must be accompanied by a Return Material Authorization (RMA) number obtained from customer service, and prepaid postage and insurance.

Liability

The Interface should only be used to control exits from areas where an alternative method for exit is available. This product is not intended for, nor is rated for operation in life-critical control applications. Mercury Security is not liable under any circumstances for loss or damage caused by or partially caused by the misapplication or malfunction of the product. Mercury Security's liability does not extend beyond the purchase price of the product.