

BioPointe Reader

Installation Guide



What's in this Guide

Installation Steps	1
Key Parts of the BioPointe Reader	2
Cabling Requirements	3
Power Connection	3
PXL-500W Wiegand Controller Connection	3
Serial Connection (RS232, RS485, or RS422)	3
Setting the DIP Switches (SW1, SW2, and SW3)	4
Connecting to the ADAM RS485 Converter	5
Connecting to LAN (Ethernet – TCP/IP)	5
Enrolling a Master User	7
Enrolling Additional Users	8
Mounting the BioPointe Unit	8
Getting Help	8

Installation Steps

Complete the following steps to install a BioPointe reader:

1. Connect the proper power.
2. Select and wire per the communication type desired.
 - a. Serial cable from the PC to one BioPointe reader
 - b. LAN connection to each BioPointe reader using LAN-50 devices
 - c. RS485 connection to one or more BioPointe readers using an ADAM interface device
3. Set the DIP switches for the communication type selected.
4. Enroll a master user.*
5. Enroll additional users.*
6. Connect all BioPointe readers to Keri PXL-500W (Wiegand) controllers for door control.
7. Enroll users in the *Doors* program: Facility Code 0, User ID# as Card Number, Wiegand card type.
8. Perform a Total Update in the *Doors* program to download all user information to the Keri controllers.

**Note: These steps may be performed using BioPointe Central software.*

Key Parts of the BioPointe Reader

The keypad is made up of the standard numeric keys, three function keys, and the ENTER and CLEAR keys.

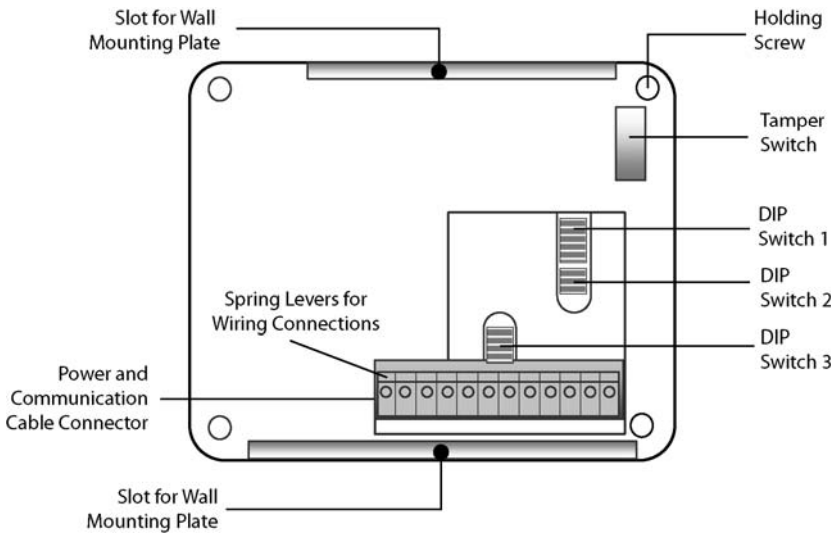
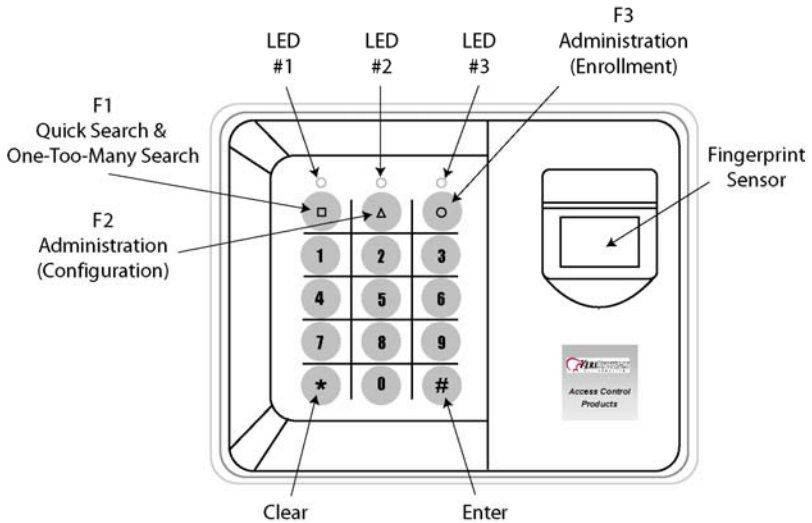

The three DIP switches are used to set the device address, communication type, and baud rate.

Cabling Requirements

BioPointe RS485: Belden 9501, 24 AWG, twisted pair, shielded.

BioPointe to PXL: Belden 3124A, one pair 18 AWG (power); one pair 22 AWG (data), shielded.

Power Connection

The BioPointe reader requires +12 to 24 VDC @ 500mA (~5w) **at the reader**. If the power supply is located more than 100 feet from the reader, the wire gauge you use must provide adequate power at the reader.

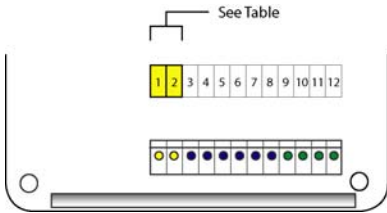

Pin	Description
1	GND
2	12 to 24 VDC

PXL-500W Wiegand Controller Connection

The Wiegand output from a BioPointe reader to a Keri Wiegand controller is connected as follows:

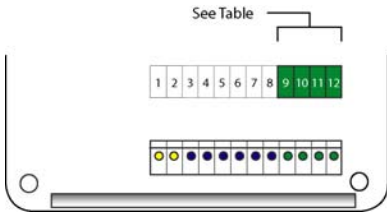

Wiegand Line	W0	GND	W1
BioPointe Output	Pin 9	Pin 10	Pin 11
PXL-500W TB5/TB6	Pin 1	Pin 4	Pin 7

Serial Connection (RS232, RS485, or RS422)

A DB-9F (female) connector is required to connect the BioPointe reader directly to a PC using a serial connection. The drawings and tables below show the pin-outs for each type of serial connection.

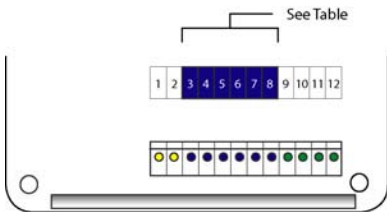

BioPointe Pin	RS-232	DB-9F Pin
3	-	-
4	-	-
5	GND	5
6	Rx	3
7	Tx	2
8	-	-

RS422 and RS485 pinouts are on the next page.

Serial Connection (RS232, RS485, or RS422 – Cont.)

BioPointe Pin	RS422	DB-9F Pin
3	Rx +	2
4	Rx -	3
5	-	-
6	Tx +	4
7	Tx -	5
8	-	-

RS422 Connections

BioPointe Pin	RS485	DB-9F Pin
3	-	-
4	-	-
5	-	-
6	D +	3
7	D -	2
8	-	-

RS485 Connections

Setting the DIP Switches (SW1, SW2, and SW3)

Note: Cycle BioPointe reader power after changing any DIP switch settings so the reader will recognize the DIP switch change.

The BioPointe reader has three DIP switches:

SW1 – Sets the Device ID

SW2 – Sets the baud rate and communications type

SW3 – Sets the serial interface type (RS232, RS422, or RS485)

SW1: 8 mini-switches to set Device ID from 1 to 254 – refer to the BioPointe Device ID Addressing Table. Device ID 0 is reserved for TCP/IP – LAN-50 devices. Device ID 255 is invalid.

SW2: 4 mini-switches, [1,2]
Baud Rate

Baud Rate (Bps)	Switch 1	Switch 2
38400 *	ON	ON
19200	-	ON
9600	-	-
2400	ON	-

* Default Value

SW2: 4 mini-switches, [3,4]
Communication Type

Comm Type	Switch 3	Switch 4
RS232 *	ON	ON
Modem	ON	-
TCP/IP	-	ON
RS422/485	-	-

* Default Value

SW3: 8 mini-switches

Interface Type	S1	S2	S3	S4	S5	S6	S7	S8
RS232 *	-	-	-	ON	-	ON	-	ON
RS422	-	ON	ON	-	ON	-	ON	-
RS485	ON	-	ON	-	ON	-	ON	-

* Default Value

Connecting to the ADAM RS485 Converter

The ADAM 4520 is an interface adapter, connected to the serial port of a PC and converts data to RS485; you can then connect one or more BioPointe devices to the ADAM. The ADAM requires 10-30 VDC, and is configured to operate at 9600 baud. You can connect the ADAM to one, or more, BioPointe readers.

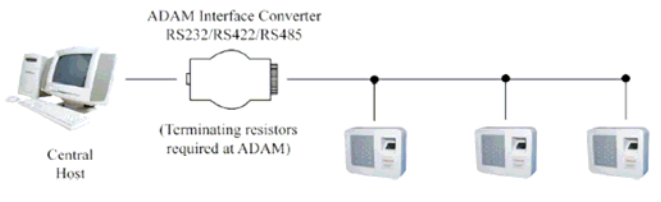

ADAM Wiring Connections

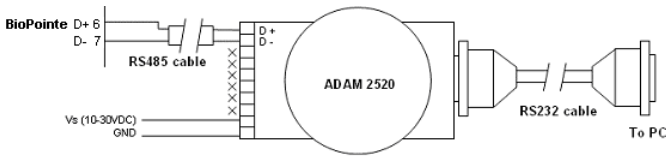

Connecting to LAN (Ethernet – TCP/IP)

The BioPointe reader may be connected to a local area network (LAN) using a Keri LAN-50 device. The LAN-50 should be assigned and addressed per the instructions in the [LAN-50/LAN-500 Application Note](#) found on the Keri CD or the Keri web site. Set the Baud rate of the LAN-50 to 38400; when the BioPointe is set for TCP/IP its baud rate defaults to 38400. The IP address assigned to the LAN-50, and port number 10001, must also be set in the BioPointe Central software by going to Tools \ Device Management System \ Device Connection Setup. Set for Ethernet, port number 10001, and the TCP/IP address of the LAN-50 to which the reader is connected, then save the configuration. Each BioPointe requires a LAN-50 unit.

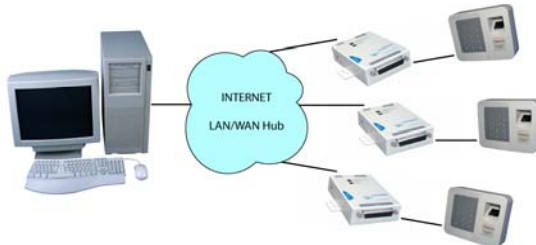

Connecting to LAN (Ethernet – TCP/IP – Cont.)

LAN-50 Wiring Connections

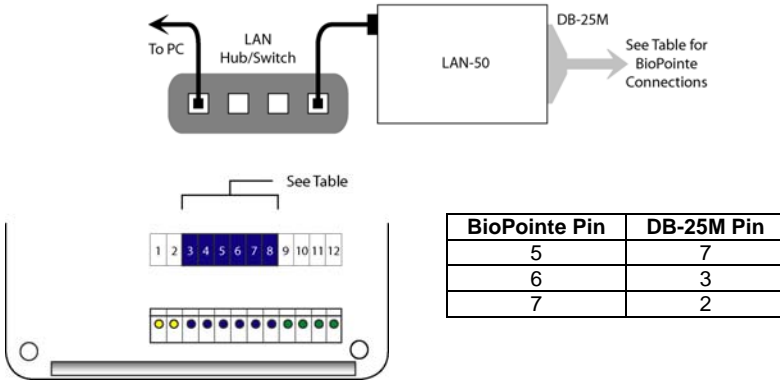

DIP Switch Settings

SW1: Device ID

Device ID 0 is reserved for TCP/IP – LAN-50 devices. For LAN-50 operation, set the BioPointe Device ID to 0 per the [BioPointe Device ID Addressing Table](#).

SW2: 4 mini-switches, [1,2] Baud Rate

Baud Rate (Bps)	Switch 1	Switch 2
38400 *	ON	ON
19200	-	ON
9600	-	-
2400	ON	-

* Default Value

SW2: 4 mini-switches, [3,4] Communication Type

Comm Type	Switch 3	Switch 4
RS232	ON	ON
Modem	ON	-
TCP/IP *	-	ON
RS422/485	-	-

* Required Value for LAN-50

SW3: 8 mini-switches

Interface Type	S1	S2	S3	S4	S5	S6	S7	S8
RS232 *	-	-	-	ON	-	ON	-	ON
RS422	-	ON	ON	-	ON	-	ON	-
RS485	ON	-	ON	-	ON	-	ON	-

* Default Value

Enrolling a Master User

When you first receive the device, there are no enrolled fingerprints. The first person to enroll becomes the first master of the device.

1. Press [Circle] [Circle] [1]

The LEDs light up per the table below (refer to the Front of Unit drawing on Page 2).

LED 1	LED 2	LED 3
Amber – Steady ON	Red – Slow Blink	Amber – Slow Blink

2. When LED 2 starts to blink slowly in red, enter a 4-digit ID. The 4-digit ID is the User ID. When the User ID is accepted, LED 2 will blink fast in red as shown below. The fingerprint sensor will also light up signifying it is ready to read.

LED 1	LED 2	LED 3
Amber – Steady ON	Red – Fast Blink	Amber – Slow Blink

3. When the fingerprint sensor lights up, place your finger on it to begin the enrollment process. Each successful enrollment requires **two** image captures. After the first image has been successfully captured, the sensor will go off. You will then hear a series of beeps acknowledging the read.

4. When you hear the series of beeps, lift up your finger and wait for the sensor to light up a second time. Place your finger back on the sensor. If this second capture image is successful; LED 1 will blink green briefly, then return to amber.

LED 1	LED 2	LED 3
Green – Blink Once		
Amber – Steady ON		

You can enroll up to three fingerprints for each User ID. LED 2 will blink fast in green in preparation for enrolling the next finger. Press [#] to continue, or [*] to exit.

LED 1	LED 2	LED 3
Amber – Steady ON	Green – Fast Blink	Amber – Slow Blink

Enrolling Additional Users

To enroll additional users, start from Step 1, but press [Circle] [Circle] [2] to start enrollment. The rest of the steps are the same as those described above. However, the third LED will blink differently to indicate the different administration mode you are in.

Mounting the BioPointe Unit

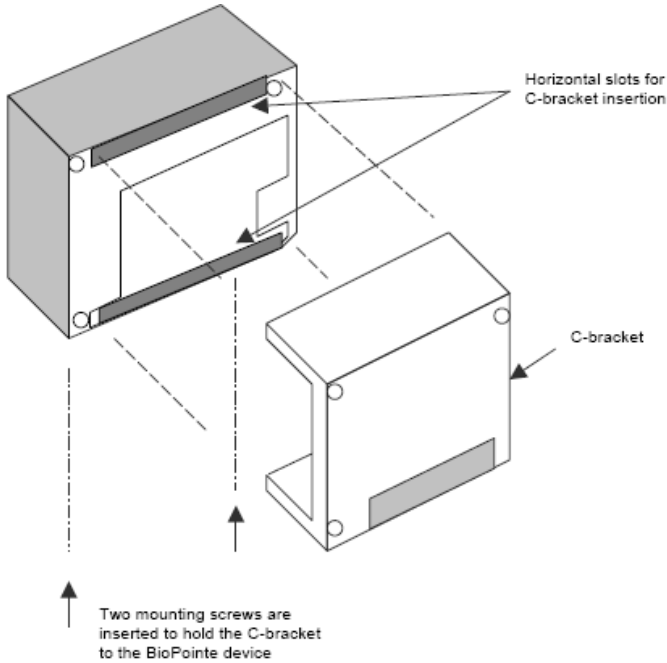

Getting Help

The Keri CD contains software and documentation for all Keri products, including the *BioPointe User's Manual* and *BioPointe Central for Windows Software Manual*. Both manuals are also available on the Keri web site www.kerisys.com.

Telephone technical support is available Monday through Friday, 6 AM to 5 PM Pacific Time, at 1-800-260-5265.